

A Series



A15



A12M

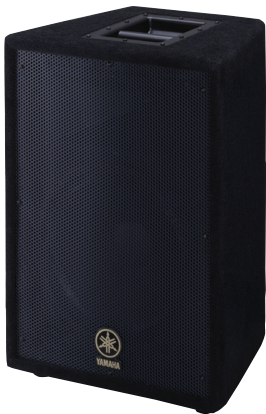

A12



A15W

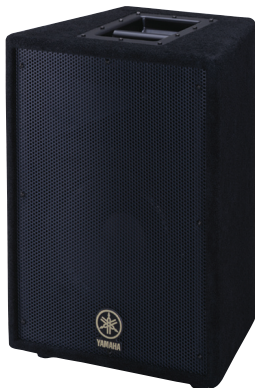

A10

Powerful Sound Output with Outstanding Clarity

From solo entertainers to touring bands, jazz clubs to houses of worship, for any situation that needs a quality sound system, Yamaha's A Series speakers are worth a good look and listen. In addition to sounding superb and being capable of handling serious power, these speakers are light, compact and easily manageable when the system needs to be moved or reconfigured. They feature durable metal handles that will withstand nightly transportation, and are pole-mountable for optimum positioning in any room.

Robust carpet covering and metal grilles are pluses, too, minimizing damage while looking downright handsome. But, of course, practicality isn't the only issue.

You want great sound, too. The A Series speakers feature optimally matched high-power woofers, compression drivers, and constant-directivity horns that deliver your sound to every corner of the room with every subtle nuance intact. There's also a range of five models to choose from, so you can create the system that is perfect for your touring or installation needs. One possible system is shown in the example below: a pair of A15 and A15W's for the house and a pair of A12M's on the floor or wherever you need them to hear precisely what you're playing or singing.

*Some models may not be available in all areas.

A Series

GENERAL SPECIFICATIONS

Model	A15	A12	A10	A12M	A15W
Type	2-way bass reflex				bass reflex
Frequency range (-10dB)	65Hz-20kHz	65Hz-20kHz	65Hz-20kHz	65Hz-20kHz	50Hz-200Hz
Nominal coverage		90H x 40V		40H x 90V	-
Nominal Impedance	8Ω	8Ω	8Ω	8Ω	8Ω
Power rating	NOISE*	200W	150W	150W	250W
	PGM	400W	300W	250W	300W
	MAX	800W	600W	500W	600W
Sensitivity (1w, 1m)	98dB SPL	97dB SPL	98dB SPL	97dB SPL	97dB SPL
Component	LF	15" cone	12" cone	10" cone	12" cone
	HF	1" VC, Horn-TW	1" VC, Horn-TW	1" VC, Horn-TW	1" VC, Horn-TW
Connectors	Speakon x 1, Phone x 1	Speakon x 1, Phone x 1	Speakon x 1, Phone x 1	Speakon x 1, Phone x 1	Speakon x 2, Phone x 2
Pole mount socket	35 mm	35 mm	35 mm	35 mm	35 mm
Dimension (W x H x D)	470 x 665 x 375 (18-1/2" x 26-3/16" x 14-13/16")	405 x 575 x 323 (15-7/8" x 22-5/8" x 12-3/4")	385 x 535 x 307 (15-3/16" x 21-1/16" x 12-1/16")	575 x 405 x 323 (22-5/8" x 15-7/8" x 12-3/4")	485 x 622 x 485 (19-1/8" x 24-1/2" x 19-1/8")
Weight	21.3Kg (46.9 lbs.)	16Kg (35.3 lbs.)	14.4Kg (31.7 lbs.)	15.6Kg (34.4 lbs.)	20.9Kg (46.1 lbs.)

* EIA RS426

DIMENSIONS

unit : mm

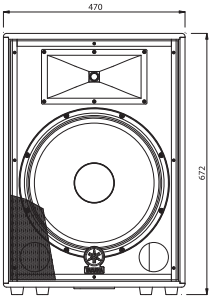
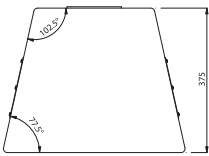

A15

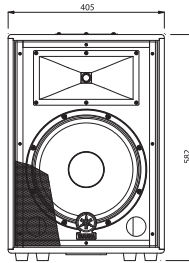
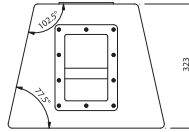

A12

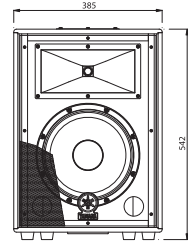
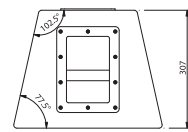

A10

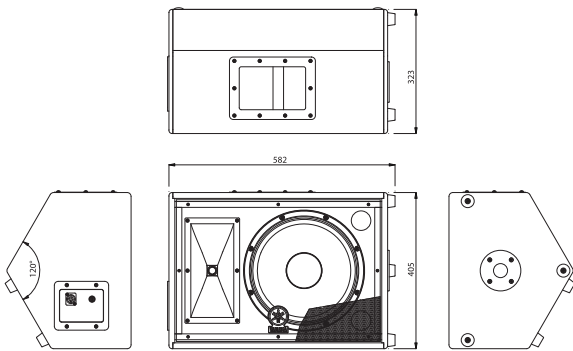

A12M

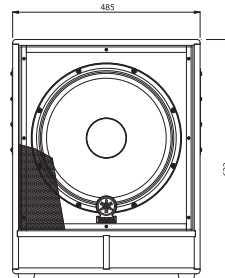
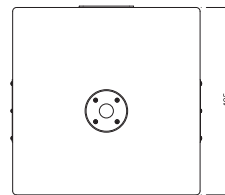

A15W

