

SONY



VPL-FHZ65 / FHZ60 / FHZ57

VPL-FWZ65 / FWZ60

3LCD Laser Installation Projectors

VPL-FH65 / FH60 / FW65 / FW60

3LCD Lamp Installation Projectors

Z-Phosphor
LASER LIGHT SOURCE



BrightEra™
Long Lasting Optics

HDMI

HDBT™
ASE

Bright, beautiful images with low running costs, minimal maintenance, and flexible installation

Because no two organisations or applications are alike, we aim to meet diverse installation and budget requirements with our range of professional laser and lamp based projectors. Offering a projection solution to suit every commercial, academic and large-scale application, our projectors have the same design, features, quality and performance in both our laser and lamp based models.

Our laser projectors (VPL-FHZ65/FHZ60/FHZ57/FWZ65/FWZ60) are ideal for a wide range of high-end business, education or large-scale applications. Their powerful Z-Phosphor laser light source is teamed with Sony's advanced 3LCD projection engine to deliver extremely bright, rich, and stable colours.

Our lamp projectors (VPL-FH65/FH60/FW65/FW60) are best suited for everyday applications and environments, offering the same advanced 3LCD projection engine with cost-effective features that deliver the same high-quality performance.

Our laser projectors deliver instant on/off to full brightness with no warm up/cool down intervals and no need to worry about lamp swaps. The laser light source means users can enjoy up to 20,000 hours of virtually maintenance-free operation*; a big benefit for many of today's education and business users. Limit tilt angle is also eliminated with a laser light source projector as they are best suited for applications with challenging installation.

Sony is always first to bring new technology to the market to enhance customer experience and expectation. The combination of Sony's laser light source and 3LCD technology is just one example where we offer a solution for every application. For long use, high demand and large scale installations, our laser projectors deliver enduring brightness. For applications where usage is less frequent, our lamp based models are the perfect solution.

All of our laser and lamp Installation projectors incorporate Reality Creation and Contrast Enhancer, two new technologies unique to Sony designed for our Home Cinema projectors.

The Reality Creation engine analyses and processes every input signal to refine detail, clarity, and sharpness for a naturally up scaled image. The Contrast Enhancer feature expands the perceived dynamic range of the signal in real-time. Both features contribute to enhancing the visual experience wherever these projectors are installed.

When choosing a projector, consistency in design, features, lenses, usability and quality is paramount and our laser and lamp Installation projectors tick all boxes.



For business



For academic use



For large scale applications



Stylish chassis design

The stylish case design features a flat top surface that blends in discreetly when the projector is ceiling mounted. The clean appearance is accentuated by a new terminal cover that reduces cable clutter.

*Actual hours vary depending on usage and environment.

High image quality

VPL-FHZ65/FHZ60/FHZ57/FWZ65/FWZ60

High image quality with 3LCD projection and laser light source technology

Combining a Z-Phosphor laser light source with a 3LCD optical system, the ground-breaking VPL-FHZ65, VPL-FHZ60, VPL-FHZ57, VPL-FWZ65 and VPL-FWZ60 projectors generate powerful, bright images with vivid colour and consistency ranging from 4,100 – 6,000 lumens in WUXGA and WXGA resolution.

Each projector's light engine uses a blue laser as its light source, which excites a phosphorous material that in turn creates white light. This white light is delivered to the 3LCD optical system, generating constant, vibrant RGB colour through a colour-splitting process. This produces brightness sufficient for a broad range of commercial, academic, and large scale applications.

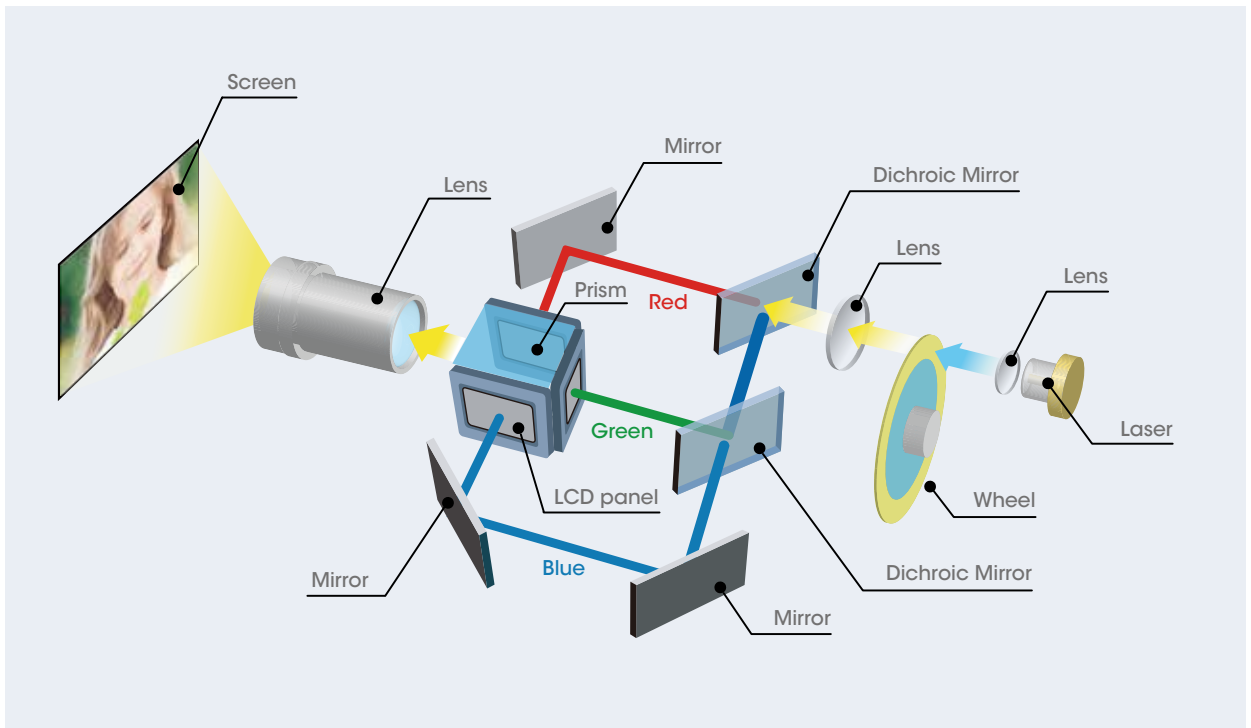

VPL-FHZ65/FHZ60/FHZ57

VPL-FH65/FH60

Detail-packed WUXGA resolution images

Our projectors deliver an amazing WUXGA resolution (1920 x 1200), exceeding Full-HD resolution (1920 x 1080) and enabling a wider display range. More information can be displayed on screen, so the whole image can be seen extremely clearly with amazing detail.

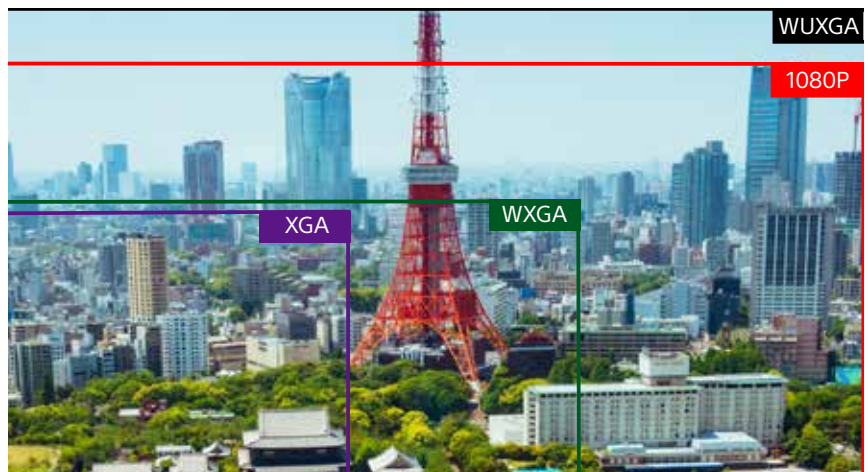

Advanced picture refinement technologies

Developed for Sony's home cinema projectors, the Reality Creation function has now been adapted for all our laser and lamp projectors. It reproduces the texture and colour of the original resolution signal by restoring missing information lost during packaging of the original contents during data transmission.

Analyse every pixel
in any direction

Sony's proprietary
algorithm

"Reality Creation"
pixel mapping

Input signal



Get the best possible images



Picture patterning based on 10 years of accumulated expertise

Simulated images

Dynamic image and high contrast

The Contrast Enhancer function, also featured in all our laser and lamp projectors, automatically adjusts the contrast for optimum viewing. It compensates for dark and bright areas of an image by analysing the signal component of each scene in real time to enhance contrast.

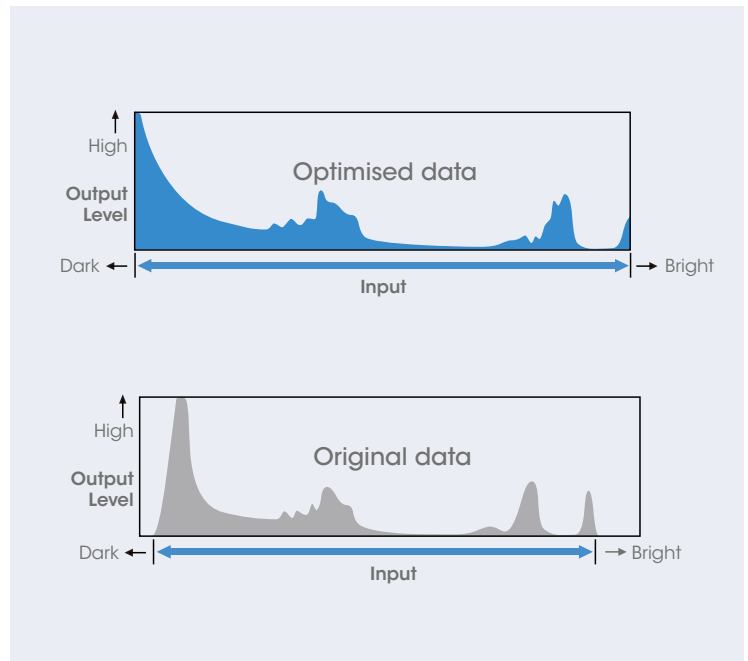

Good TCO & energy efficient

VPL-FHZ65/FHZ60/FHZ57/FWZ65/FWZ60

Up to 20,000 hours of virtually maintenance-free operation*

Thanks to the Z-Phosphor laser light source with control technology, long-life 3LCD panels and advanced filter system, all Sony laser projectors offer up to 20,000 hours of virtually maintenance-free operation. Combined with a range of energy-saving features, total lifetime ownership costs are reduced compared with conventional lamp projectors.

* Actual hours vary depending on usage and environment.

VPL-FHZ65/FHZ60/FHZ57/FWZ65/FWZ60

VPL-FH65/FH60/FW65/FW60

Hassle-free automatic filter cleaning

Arduous maintenance tasks are eliminated on all laser and lamp models. A new automated cleaning system removes filter dust every 100 hours when the projector is powered off.

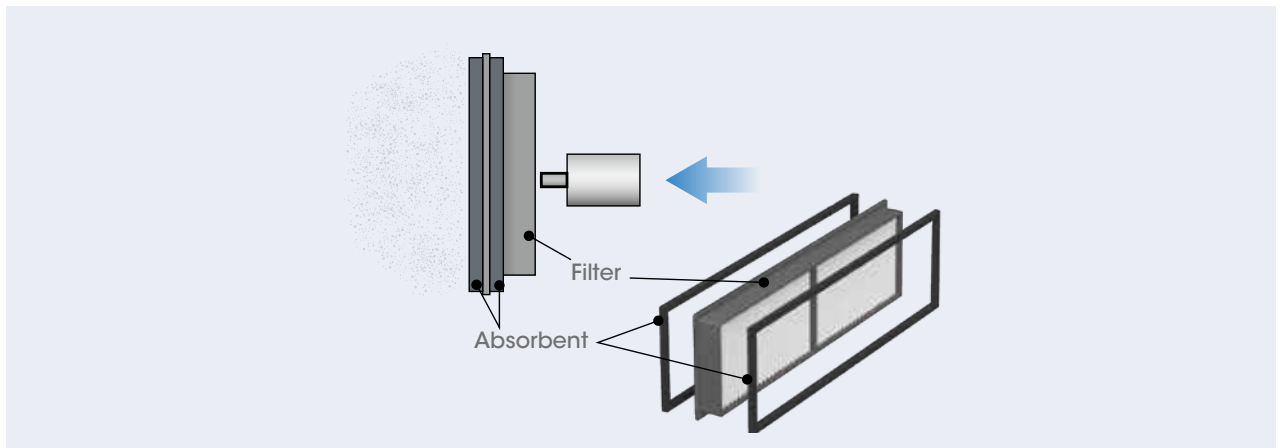

Energy-efficient functions

VPL-FHZ65/FHZ60/FHZ57/FWZ65/FWZ60

Auto dimming mode

All of our laser projectors are equipped with an auto brightness dimming function. After 10 seconds of a static signal feed, the brightness automatically dims by approximately 15% which is unlikely to be noticed by the audience. If left powered on while not in use, the unit will automatically dim the brightness to as low as approximately 5% of original brightness to significantly reduce energy consumption. The time period for when this occurs can be set by the user. Any detection of a new signal instantly returns the projector to full brightness.

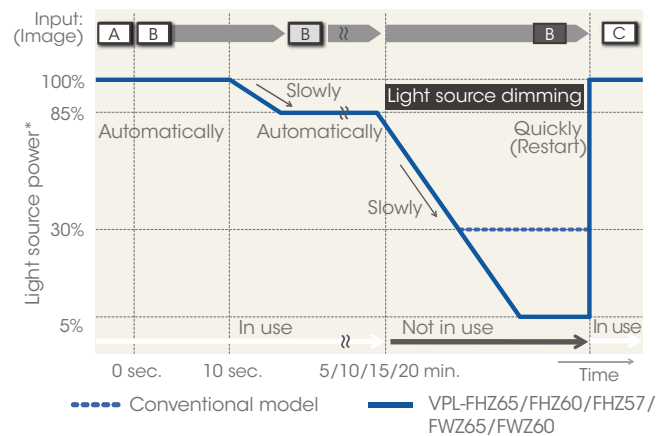

* Light source mode: High. The values are approximate.

When the input signal is unchanged, the unit shifts into dimming mode

Simulated images

Auto light source control for energy saving

The brightness of the light source's output is automatically adjusted depending on the brightness of the projected image, to avoid unnecessary power consumption. When showing darker images that don't require high brightness, the light source output decreases.

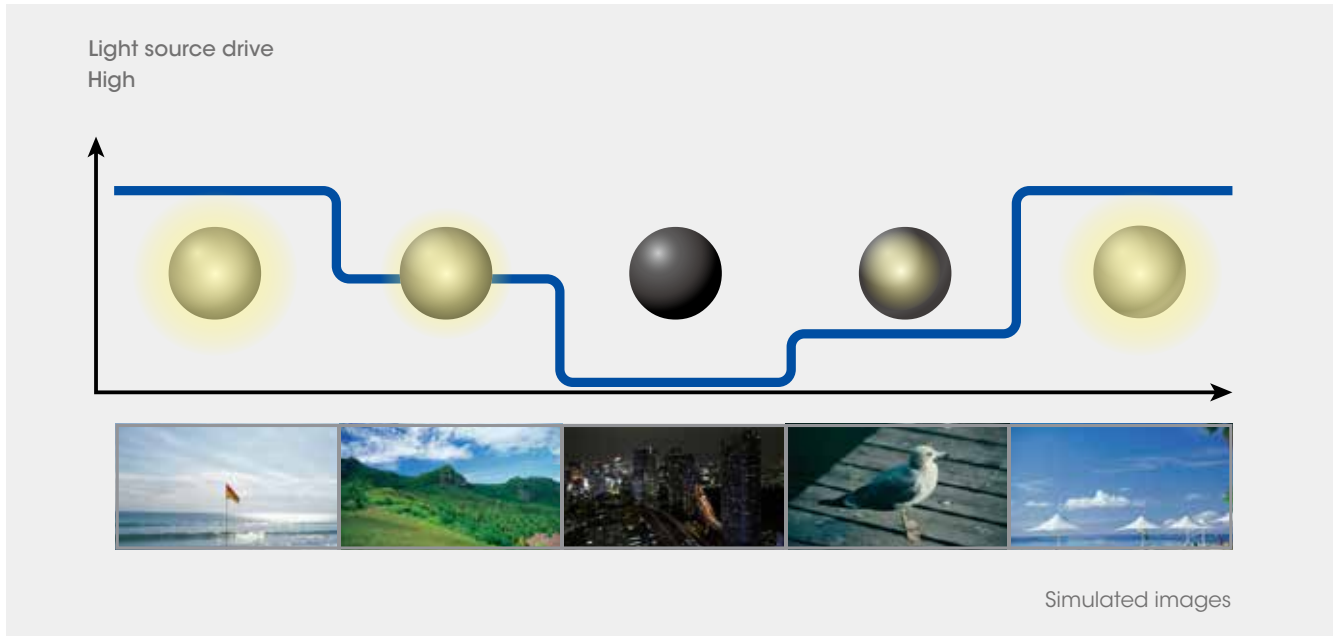

Simulated images

Blank (ECO picture muting)

This feature allows the user to redirect the attention of their audience without turning the projector off, but still reduce power consumption. Blank, or ECO Picture Mute temporarily disables any signal output allowing a "blank" image and low power consumption. Switch Blank or ECO Picture Mute back on, and the image is instantly back on at full brightness.

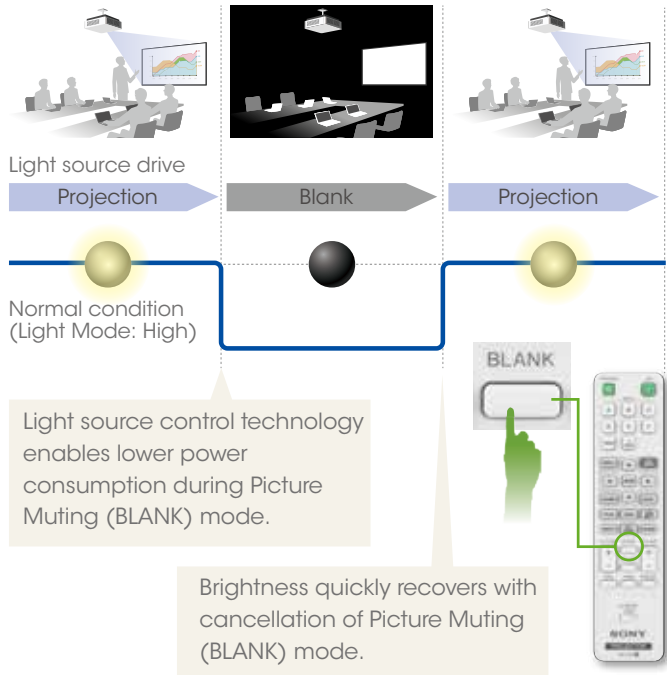

Simulated images

Installation advantages

VPL-FHZ65/FHZ60/FHZ57/FWZ65/FWZ60

VPL-FH65/FH60/FW65/FW60

Powered lens shift function*

All Laser and lamp projectors have an exceptional standard lens shift range of +/- 32% horizontally and -5%/+60% vertically. Images can be easily adjusted to the desired settings during installation. With this exceptional lens shift range, the projectors can be installed in ways to maximise performance even in the most difficult environments.

*Optional lenses available and vary in lens shift performance.

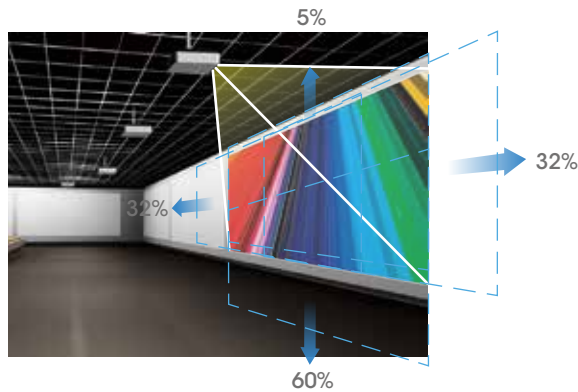

* Depends on lens

Simulated images

VPL-FHZ65/FHZ60/FHZ57/FWZ65/FWZ60

Tilt angle-free

Enjoy greater installation flexibility with laser light source technology by positioning the projector freely at any angle.

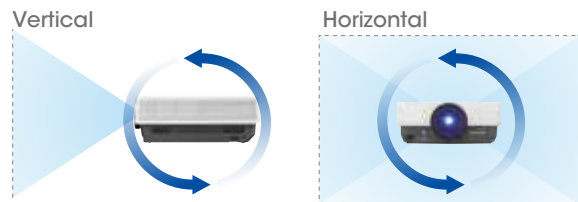

Simulated images

VPL-FHZ65/FHZ60/FHZ57/FWZ65/FWZ60

VPL-FH65/FH60/FW65/FW60

Simple installation with HDBaseT

HDBaseT is a multi-signal transmission system via a single cable, which simplifies installation. It cuts total system cost by reducing not just cabling requirements but also the number of required signal extenders and receiver boxes. Fewer signal extenders and receiver boxes mean fewer potential points of failure.

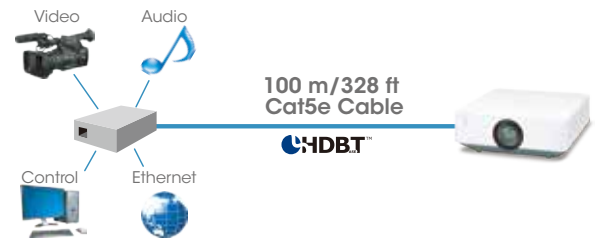

VPL-FHZ65/FHZ60/FHZ57/FWZ65/FWZ60

VPL-FH65/FH60/FW65/FW60

Supersize displays with on-board edge-blending

All models have on-board edge blending capabilities allowing for multiple projectors to overlay images and project seamlessly large panoramic size images.



Simulated images

VPL-FHZ65/FHZ60/FHZ57/FWZ65/FWZ60

VPL-FH65/FH60/FW65/FW60

Super quiet operation

Sony's installation projectors are one of the industry's quietest. Low fan noise, 35 dB/28 dB* (Lamp Mode: High/Standard) ensures discreet, unobtrusive operation in quiet environments, from museums and galleries to lecture theatres.

*as of February 2016



Optional lenses

Projection lens	VPLL-3003**	VPLL-3007	VPLL-Z3009	VPLL-Z3024	VPLL-Z3032
Throw ratio	0.33:1	0.65:1	0.85:1 to 1.0:1	2.34:1 to 3.19:1	3.18:1 to 4.84:1
Zoom / Focus	— / Powered	— / Manual	Manual / Manual	Powered / Powered	Powered / Powered
Lens shift	Vertical: Upward 5% to Downward 5% Horizontal: Right 5% to Left 5%	Vertical: Upward 10% to Downward 5% Horizontal: Right 4% to Left 4%	Vertical: Upward 50% to Downward 5% Horizontal: Right 24% to Left 24%	Vertical: Upward 60% to Downward 5% Horizontal: Right 32% to Left 32%	Vertical: Upward 60% to Downward 5% Horizontal: Right 32% to Left 32%
Aperture	f/1.85	f/1.75	f/1.85 to 2.1	f/2.00 to 2.30	f/2.00 to 2.40
Screen size*	80" to 300"	60" to 300"	60" to 300"	40" to 600"	40" to 600"
Dimensions	W 229 x H 193.7 x D 424.7 mm	W 150 x H 150 x D 222 mm	W 150 x H 150 x D 217 mm	W 97 x H 105 x D 177 mm	W 97 x H 105 x D 177 mm
Mass	2.9 kg	1.7 kg	1.7 kg	1.2 kg	1.2 kg

* Viewable area, measured diagonally.

Lens throw ratio chart

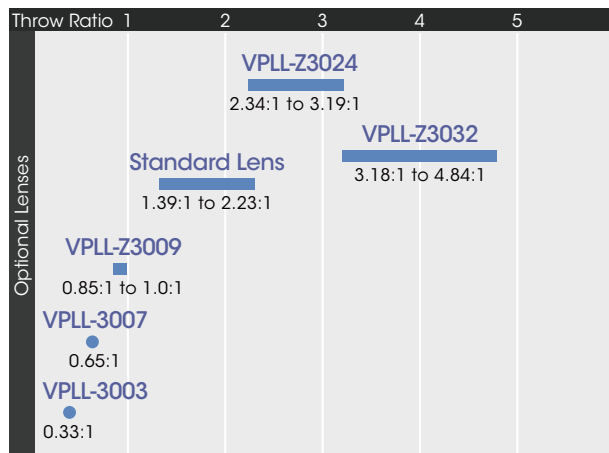

The distance L is between the front of the lens (center) and the front of the cabinet.

Unit: mm (inches)

Lens	L'	Type
Standard lens	1.2 (1/6)	②
VPLL-3003	256 (10 3/32)	②
VPLL-3007	52.4 (2 1/16)	②
VPLL-Z3009	51.2 (2 1/32)	②
VPLL-Z3024	9.9 (3/8)	②
VPLL-Z3032	9.9 (3/8)	②

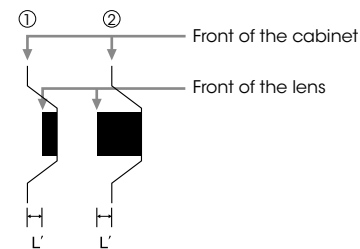

Installation diagram

Unit: m (inches)

Projection image size		Standard lens	VPLL-3007	VPLL-Z3009	VPLL-Z3024	VPLL-Z3032
Diagonal	Width x Height					
80-inch (2.03 m)	1.72 x 1.08 (68 x 42)	2.36 – 3.86 (93 – 152)	1.09 (43)	1.44 – 1.69 (57 – 66)	4.00 – 5.48 (158 – 215)	5.45 – 8.32 (215 – 327)
100-inch (2.54 m)	2.15 x 1.35 (85 x 53)	2.96 – 4.84 (117 – 191)	1.38 (54)	1.82 – 2.13 (72 – 84)	5.03 – 6.87 (198 – 270)	6.84 – 10.43 (270 – 410)
120-inch (3.05 m)	2.58 x 1.62 (102 x 64)	3.57 – 5.82 (141 – 229)	1.67 (66)	2.20 – 2.57 (87 – 101)	6.05 – 8.27 (238 – 325)	8.24 – 12.55 (325 – 494)
150-inch (3.81 m)	3.23 x 2.02 (127 x 79)	4.47 – 7.29 (176 – 287)	2.11 (83)	2.76 – 3.23 (109 – 127)	7.59 – 10.36 (299 – 408)	10.33 – 15.72 (407 – 619)
200-inch (5.08 m)	4.31 x 2.69 (170 x 106)	5.97 – 9.73 (235 – 383)	2.83 (112)	3.70 – 4.34 (146 – 170)	10.15 – 13.85 (400 – 545)	13.82 – 21.00 (544 – 827)

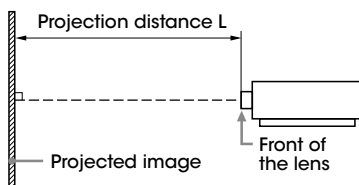

Preset signal chart

Computer signal

Resolution	fH [kHz]/ fV [Hz]	Input connector	
		RGB*1	DVI-D ² /HDMI ⁶ / Digital Interface Adaptor BKM- PJ10 ⁷ /3G-SDI INPUT Adaptor BKM-PJ20 ⁷
640 x 350	31.5/70	●	—
	37.9/85	●	—
640 x 400	31.5/70	●	—
	37.9/85	●	—
640 x 480	31.5/60	●	●
	35.0/67	●	—
	37.9/73	●	—
	37.5/75	●	—
	43.3/85	●	—
800 x 600	35.2/56	●	—
	37.9/60	●	●
	48.1/72	●	—
	46.9/75	●	—
	53.7/85	●	—
832 x 624	49.7/75	●	—
1024 x 768	48.4/60	●	●
	56.5/70	●	—
	60.0/75	●	—
1152 x 864	68.7/85	●	—
	64.0/70	●	—
	67.5/75	●	—
1152 x 900	77.5/85	●	—
	61.8/66	●	—
1280 x 960	60.0/60	●	●
	75.0/75	●	—
1280 x 1024	64.0/60	●	—
	80.0/75	●	—
	91.1/85	●	—
1400 x 1050	65.3/60	●	●
1600 x 1200	75.0/60	●	●
1280 x 768	47.8/60	●	●
1280 x 720	45.0/60	●	●*2
1920 x 1080	67.5/60	—	●*2
1366 x 768	47.7/60	●	●
1440 x 900	55.9/60	●	●
1680 x 1050	65.3/60	●	●
1280 x 800	49.7/60	●	●
1920 x 1200	74.0/60	●*1	●*1
1600 x 900	60.0/60	●*1	●*1

Video signal

Signal	fV [Hz]	Input connector		
		VIDEO/ S VIDEO	INPUT A	INPUT B/ INPUT C/ INPUT D
NTSC	60	●	—	—
PAL/SECAM	50	●	—	—
480i	60	—	●	●
576i	50	—	●	●
480p	60	—	●	●
576p	50	—	●	●
1080i	60	—	●	●
1080i	50	—	●	●
720p	60	—	●	●*2
720p	50	—	●	●
1080p	60	—	—	●*2
1080p	50	—	—	●
1080p	24	—	—	●

*1: Available for VESA Reduced Blanking signals only.

*2: INPUT B is determined as a computer signal; INPUT C/INPUT D is determined as a video signal.

- When a signal other than the signals listed in the table is input, the picture may not be displayed properly.
- An input signal meant for a screen resolution that differs from that of the panel will not be displayed in its original resolution. Text and lines may be uneven.
- Some actual value may differ slightly from the design values given in the table.

Optional accessories



LMP-F370
Projector lamp replacement for the VPL-FH65 and VPL-FW65



LMP-F280
Projector lamp replacement for the VPL-FH60 and VPL-FW60



LKRA-FL1
Optical Filter for 3D Applications



LKRA-FL2
Optical Filter for Angular Projection



PSS-650
Projector Suspension Support



PSS-650P
Projector Suspension Support Joint Pole

Connector panels

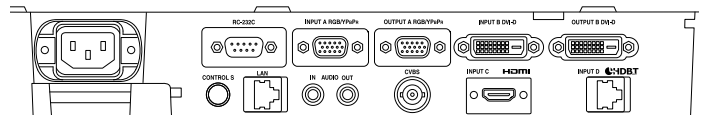

Dimensions

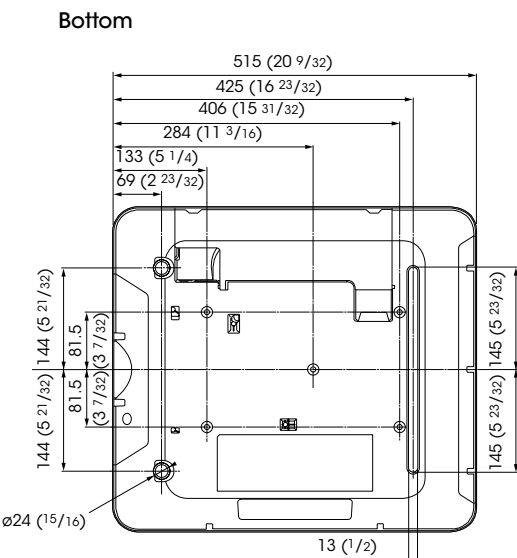
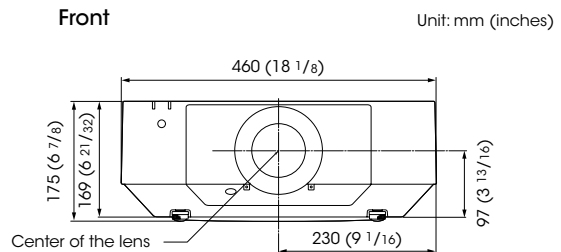

Specifications

		VPL-FHZ65	VPL-FHZ60	VPL-FHZ57	VPL-FWZ65	VPL-FWZ60
Display system		3 LCD system				
Display device	Size of effective display area	0.76" (19 mm) x 3 BrightEra LCD Panel, Aspect ratio: 16:10				
	Number of pixels	6,912,000 (1920 x 1200 x 3) pixels			3,072,000 (1280 x 800 x 3) pixels	
Projection lens*1	Zoom	Powered (Approx. x 1.6)				
	Focus	Powered				
	Lens shift	Powered, Vertical: -5%, +60%, Horizontal: +/-32%				
	Throw ratio	1.39:1 to 2.23:1				
Light source		Laser diode				
Recommended lamp replacement time*2		—				
Filter cleaning / replacement cycle (Max.)*2		20,000 H (service maintenance)				
Screen size		40" to 600" (1.02 m to 15.24 m) (measured diagonally)				
Light output (Mode: High / Standard)		6000 lm / 4000 lm	5000 lm / 3500 lm	4100 lm / 3000 lm	6000 lm / 4000 lm	5000 lm / 3500 lm
Color light output (Mode: High / Standard)		6000 lm / 4000 lm	5000 lm / 3500 lm	4100 lm / 3000 lm	6000 lm / 4000 lm	5000 lm / 3500 lm
Contrast ratio*3 (full white / full black)		10000:1				
Displayable scanning frequency	Horizontal	15kHz to 92kHz				
	Vertical	48Hz to 92Hz				
Display resolution	Computer signal input	Maximum display resolution: 1920 x 1200 dots*4				
	Video signal input	NTSC, PAL, SECAM, 480/60i, 576/50i, 480/60p, 576/50p, 720/60p, 720/50p, 1080/60i, 1080/50i The following items are available for digital signal only; 1080/60p, 1080/50p, 1080/24p				
Color system		NTSC3.58, PAL, SECAM, NTSC4.43, PAL-M, PAL-N, PAL60				
Keystone correction (Max.)		Vertical: +/- 30 degrees Horizontal: +/- 30 degrees				
OSD language		24-languages (English, Dutch, French, Italian, German, Spanish, Portuguese, Turkish, Polish, Russian, Swedish, Norwegian, Japanese, Simplified Chinese, Traditional Chinese, Korean, Thai, Vietnamese, Arabic, Farsi, Finnish, Indonesian, Hungarian, Greek)				
Computer and video signal input/output	INPUT A	RGB / Y Pb Pr input connector: Mini D-sub 15-pin (female), Audio input connector: Stereo mini jack				
	INPUT B	DVI input connector: DVI-D 24-pin (single link), HDCP support, Audio input connector: Shared with INPUT A				
	INPUT C	HDMI input connector: HDMI 19-pin, HDCP support, Audio input connector: HDMI audio support				
	INPUT D	HDBaseT interface connector: RJ45, 4 play (Video, Audio, LAN, Control)				
	VIDEO IN	Video input connector: BNC, Audio input connector: Shared with input A				
	OUTPUT A	Monitor output for Input A Connector: Mini D-sub 15-pin (female), Audio output connector: Stereo mini jack				
Control signal input/output		Monitor output for Input B Connector: DVI-D 24-pin (single link), HDCP not supported, Audio output, Monitor out connector: Stereo mini jack				
Acoustic Noise (Mode: High / Standard)		RS-232C connector: D-sub 9-pin (male), LAN connector: RJ45, 10BASE-T / 100BASE-TX, IR (Control S) connector: Stereo mini jack, Plug in power DC 5 V 34 dB / 28 dB				
Operating temperature (Operating humidity)		0°C to 40°C (32°F to 104°F) / 20% to 80% (no condensation)				
Storage temperature (Storage humidity)		-10°C to +60°C (14°F to +140°F) / 20% to 80% (no condensation)				
Power requirements		AC 100 V to 240 V, 5.5 A to 2.3 A, 50 Hz / 60 Hz	AC 100 V to 240 V, 4.5 A to 1.9 A, 50 Hz / 60 Hz	AC 100 V to 240 V, 4.5 A to 1.9 A, 50 Hz / 60 Hz	AC 100 V to 240 V, 5.5 A to 2.3 A, 50 Hz / 60 Hz	AC 100 V to 240 V, 5.5 A to 2.3 A, 50 Hz / 60 Hz
Power consumption (Mode: High / Standard)	AC 100 V to 120 V	509 W / 298 W	420 W / 272 W	370 W / 234 W	464 W / 245 W	383 W / 227 W
	AC 220 V to 240 V	492 W / 283 W	408 W / 266 W	355 W / 229 W	453 W / 241 W	372 W / 223 W
Power Consumption (Standby Mode)	AC 100 V to 120 V	0.5 W (when "Standby mode" is set to "Low")				
	AC 220 V to 240 V	0.5 W (when "Standby mode" is set to "Low")				
Power Consumption (Networked Standby Mode)	AC 100 V to 120 V	15.0 W (All terminals and networks connected, when "Standby Mode" is set to "Standard")				
	AC 220 V to 240 V	13.3 W (All terminals and networks connected, when "Standby Mode" is set to "Standard")				
Heat dissipation	AC 100 V to 120 V	1737 BTU/h	1433 BTU/h	1262 BTU/h	1583 BTU/h	1307 BTU/h
	AC 220 V to 240 V	1679 BTU/h	1393 BTU/h	1211 BTU/h	1546 BTU/h	1269 BTU/h
Outside dimensions		Approx. W 460 x H 169 x D 515 mm (W 18 1/8 x H 6 21/32 x D 20 9/32 in) (without protrusions)				
Mass		Approx. 1.6 kg (34 lb)				
Supplied accessories		RM-PJ27 Remote Commander (1), Size AA (R6) batteries (2), AC Power Cord (1), Plug holder*5 (1), Terminal cover (1), Quick Reference Manual (1), Operating Instructions (CD-ROM) (1)				
Replacement lamp		—				

*1 With supplied standard lens

*2 This figure is the expected maintenance time, not a guaranteed time.
The actual value depends on the environment and how the projector is used.

*3 The value is average.

*4 Available for VESA Reduced Blanking signal.

*5 VPL-FHZ65/VPL-FHZ60/VPL-FHZ57/VPL-FWZ65/VPL-FWZ60

LASER NOTICES
For the U.S.A. and Canada
IEC 60825-1:2007

For other countries
IEC 60825-1:2014



CLASS 1 LASER PRODUCT
RISK GROUP 3 to IEC 62471:2006
Warning: Possibly hazardous optical radiation emitted from this product.



Specifications

		VPL-FH65	VPL-FH60	VPL-FW65	VPL-FW60
Display system		3 LCD system			
Display device	Size of effective display area	0.76" (19 mm) x 3 BrightEra LCD Panel, Aspect ratio: 16:10			
	Number of pixels	6,912,000 (1920 x 1200 x 3) pixels		3,072,000 (1280 x 800 x 3) pixels	
Projection lens*1	Zoom	Powered (Approx. x 1.6)			
	Focus	Powered			
	Lens shift	Powered, Vertical: -5%, +60%, Horizontal: +/-32%			
	Throw ratio	1.39:1 to 2.23:1			
Light source		High pressure mercury lamp 370 W type	High pressure mercury lamp 280 W type	High pressure mercury lamp 370 W type	High pressure mercury lamp 280 W type
Recommended lamp replacement time*2		3,000 H / 4,000 H (Lamp mode: High / Standard)			
Filter cleaning / replacement cycle (Max.)*2		20,000 H (service maintenance)			
Screen size		40" to 600" (1.02 m to 15.24 m) (measured diagonally)			
Light output (Mode: High / Standard)		6000 lm / 4400 lm	5000 lm / 3,200 lm	6300 lm / 4780 lm	5200 lm / 3400 lm
Color light output (Mode: High / Standard)		6000 lm / 4400 lm	5000 lm / 3,200 lm	6300 lm / 4780 lm	5200 lm / 3400 lm
Contrast ratio*3 (full white / full black)		2000 : 1			
Displayable scanning frequency	Horizontal	15kHz to 92kHz			
	Vertical	48Hz to 92Hz			
Display resolution	Computer signal input	Maximum display resolution: 1920 x 1200 dots*4			
	Video signal input	NTSC, PAL, SECAM, 480/60i, 576/50i, 480/60p, 576/50p, 720/60p, 720/50p, 1080/60i, 1080/50i The following items are available for digital signal only: 1080/60p, 1080/50p, 1080/24p			
Color system		NTSC3.58, PAL, SECAM, NTSC4.43, PAL-M, PAL-N, PAL60			
Keystone correction (Max.)		Vertical: +/- 30 degrees Horizontal: +/- 30 degrees			
OSD language		24-languages (English, Dutch, French, Italian, German, Spanish, Portuguese, Turkish, Polish, Russian, Swedish, Norwegian, Japanese, Simplified Chinese, Traditional Chinese, Korean, Thai, Vietnamese, Arabic, Farsi, Finnish, Indonesian, Hungarian, Greek)			
Computer and video signal input/output	INPUT A	RGB / Y Pb Pr input connector: Mini D-sub 15-pin (female), Audio input connector: Stereo mini jack			
	INPUT B	DVI input connector: DVI-D 24-pin (single link), HDCP support, Audio input connector: Shared with input A			
	INPUT C	HDMI input connector: HDMI 19-pin, HDCP support, Audio input connector: HDMI audio support			
	INPUT D	HDBaseT interface connector: RJ45, 4 play (Video, Audio, LAN, Control)			
	VIDEO IN	Video input connector: BNC, Audio input connector: Shared with input A			
	OUTPUT A	Monitor output for Input A Connector: Mini D-sub 15-pin (female), Audio output connector: Stereo mini jack			
	OUTPUT B	Monitor output for Input B Connector: DVI-D 24-pin (single link), HDCP not supported, Audio output, Monitor out connector: Stereo mini jack			
Control signal input/output		RS-232C connector: D-sub 9-pin (male), LAN connector: RJ45, 10BASE-T / 100BASE-TX, IR (Control S) connector: Stereo mini jack, Plug in power DC 5 V			
Acoustic Noise (Mode: High / Standard)		34 dB / 28 dB		35 dB / 28 dB	
Operating temperature (Operating humidity)		0°C to 40°C (32°F to 104°F) / 20% to 80% (no condensation)			
Storage temperature (Storage humidity)		-10°C to +60°C (14°F to +140°F) / 20% to 80% (no condensation)			
Power requirements		AC 100 V to 240 V, 5.0 A to 2.1 A, 50 Hz / 60 Hz	AC 100 V to 240 V, 4.3 A to 1.8 A, 50 Hz / 60 Hz	AC 100 V to 240 V, 5.0 A to 2.1 A, 50 Hz / 60 Hz	AC 100 V to 240 V, 4.3 A to 1.8 A, 50 Hz / 60 Hz
Power consumption (Mode: High / Standard)	AC 100 V to 120 V	498 W / 346 W	429 W / 268 W	470 W / 336 W	416 W / 256 W
	AC 220 V to 240 V	483 W / 337 W	416 W / 261 W	455 W / 328 W	404 W / 252 W
Power Consumption (Standby Mode)	AC 100 V to 120 V	0.5 W (when "Standby mode" is set to "Low")			
	AC 220 V to 240 V	0.5 W (when "Standby mode" is set to "Low")			
Power Consumption (Networked Standby Mode)	AC 100 V to 120 V	15.0 W (All terminals and networks connected, when "Standby Mode" is set to "Standard")			
	AC 220 V to 240 V	13.3 W (All terminals and networks connected, when "Standby Mode" is set to "Standard")			
Heat dissipation	AC 100 V to 120 V	1699 BTU/h	1464 BTU/h	1604 BTU/h	1419 BTU/h
	AC 220 V to 240 V	1648 BTU/h	1419 BTU/h	1552 BTU/h	1378 BTU/h
Outside dimensions		Approx. W 460 x H 169 x D 515 mm (W 18 1/8 x H 6 21/32 x D 20 9/32 in) (without protrusions)			
Mass		Approx. 13 kg (28 lb)			
Supplied accessories		RM-PJ27 Remote Commander (1), Size AA (R6) batteries (2), AC Power Cord (1), Plug holder (1), Terminal cover (1), Quick Reference Manual (1), Operating Instructions (CD-ROM) (1)			
Replacement lamp		LMP-F370	LMP-F280	LMP-F370	LMP-F280

*1 With supplied standard lens

*2 This figure is the expected maintenance time, not a guaranteed time.

The actual value depends on the environment and how the projector is used.

*3 The value is average.

*4 Available for VESA Reduced Blanking signal.

SONY

Distributed by

PEAK
CONFERENCE
www.PeakConference.com

©2016 Sony Corporation. All rights reserved.

Reproduction in whole or in part without written permission is prohibited.

Features and specifications are subject to change without notice.

The values for mass and dimension are approximate.

"SONY", "Z-Phosphor", "BrightEra" and "Remote Commander" are trademarks of Sony Corporation.

Trademark PJLink is a trademark applied for trademark rights in Japan, the United States of America and other countries and areas.

The terms HDMI and HDMI High-Definition Multimedia Interface, and the HDMI Logo are trademarks or registered trademarks of HDMI Licensing LLC in the United States and other countries.

All other trademarks are the property of their respective owners.

HDBaseT™ and the HDBaseT Alliance logo are trademarks of the HDBaseT Alliance.