

A Series



A15



A12M



A12



A15W

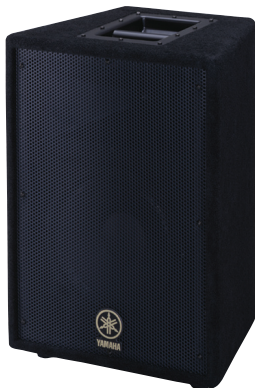

A10

Powerful Sound Output with Outstanding Clarity

From solo entertainers to touring bands, jazz clubs to houses of worship, for any situation that needs a quality sound system, Yamaha's A Series speakers are worth a good look and listen. In addition to sounding superb and being capable of handling serious power, these speakers are light, compact and easily manageable when the system needs to be moved or reconfigured. They feature durable metal handles that will withstand nightly transportation, and are pole-mountable for optimum positioning in any room.

Robust carpet covering and metal grilles are pluses, too, minimizing damage while looking downright handsome. But, of course, practicality isn't the only issue.

You want great sound, too. The A Series speakers feature optimally matched high-power woofers, compression drivers, and constant-directivity horns that deliver your sound to every corner of the room with every subtle nuance intact. There's also a range of five models to choose from, so you can create the system that is perfect for your touring or installation needs. One possible system is shown in the example below: a pair of A15 and A15W's for the house and a pair of A12M's on the floor or wherever you need them to hear precisely what you're playing or singing.

*Some models may not be available in all areas.

A Series

GENERAL SPECIFICATIONS

| Model | A15 | A12 | A10 | A12M | A15W |
|-------------------------|---|--|---|--|--|
| Type | 2-way bass reflex | | | | |
| Frequency range (-10dB) | 65Hz-20kHz | 65Hz-20kHz | 65Hz-20kHz | 65Hz-20kHz | 50Hz-200Hz |
| Nominal coverage | 90H x 40V | | | | |
| Nominal Impedance | 8Ω | 8Ω | 8Ω | 8Ω | 8Ω |
| Power rating | NOISE* | 150W | 125W | 150W | 250W |
| | PGM | 400W | 300W | 300W | 500W |
| | MAX | 800W | 600W | 500W | 1000W |
| Sensitivity (1w, 1m) | 98dB SPL | 97dB SPL | 98dB SPL | 97dB SPL | 97dB SPL |
| Component | LF | 12" cone | 10" cone | 12" cone | 15" cone |
| | HF | 1" VC, Horn-TW | 1" VC, Horn-TW | 1" VC, Horn-TW | 1" VC, Horn-TW |
| Connectors | Speakon x 1, Phone x 1 | Speakon x 1, Phone x 1 | Speakon x 1, Phone x 1 | Speakon x 1, Phone x 1 | Speakon x 2, Phone x 2 |
| Pole mount socket | 35 mm | 35 mm | 35 mm | 35 mm | 35 mm |
| Dimension (W x H x D) | 470 x 665 x 375 (18-1/2" x 26-3/16" x 14-13/16") | 405 x 575 x 323 (15-7/8" x 22-5/8" x 12-3/4") | 385 x 535 x 307 (15-3/16" x 21-1/16" x 12-1/16") | 575 x 405 x 323 (22-5/8" x 15-7/8" x 12-3/4") | 485 x 622 x 485 (19-1/8" x 24-1/2" x 19-1/8") |
| Weight | 21.3Kg (46.9 lbs.) | 16Kg (35.3 lbs.) | 14.4Kg (31.7 lbs.) | 15.6Kg (34.4 lbs.) | 20.9Kg (46.1 lbs.) |

* EIA RS426

DIMENSIONS

unit : mm

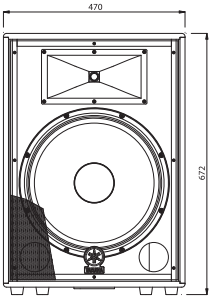
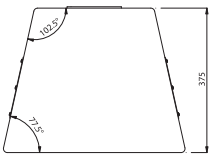

A15

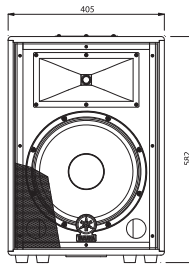
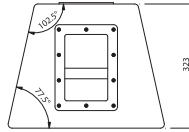

A12

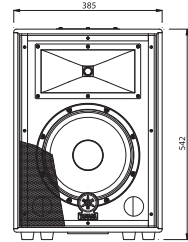
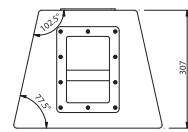

A10

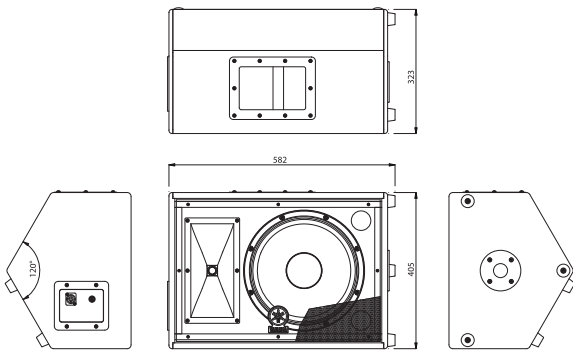

A12M

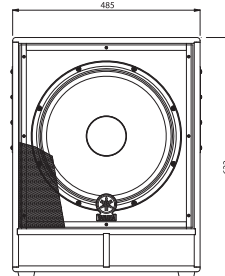
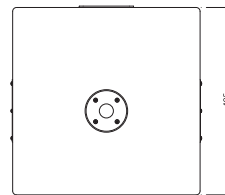

A15W