

SONY



VPL-C200 Series

Data Projectors

VPL-CW276 VPL-CW256
VPL-CX276 VPL-CX236



BrightEra™ **HDMI**

Everything You Expect From Sony: Flexibility, Efficiency, Quality and Style

The VPL-C200 Series offers installation flexibility, energy efficiency with a low total cost ownership, and high image quality and delivers it all in a stylish design that blends into any decor. Image correction features and a lens shift/zoom capability enable users to easily fit any image onto the screen, even from an offset projection angle.

In addition, these installation projectors are thoughtfully designed for optimum energy efficiency with a reduced total cost of ownership. They feature an auto power saving function, picture muting function with lamp control technology, long-lasting lamp, and low power consumption.

Every model delivers high image quality. The VPL-CW276 offers 5,100 lumens* brightness and the VPL-CW256 4,500 lumens*. Both models support wide screen projection with WXGA resolution. The VPL-CX276 offers 5,200 lumens* brightness and the VPL-CX236 4,100 lumens*. These two models provide high image quality with XGA resolution.

With all the features and functionality that you expect from Sony – particularly easy installation and usability, energy efficiency and low maintenance, and dependable image quality – VPL-C200 Series projectors are ideal for mid- to large-size classrooms, conference rooms, and many similar environments.

* ISO 21118

FEATURES

High Image Quality

3LCD BrightEra™ Natural and Vivid Color Images

Thanks to the optical system constantly projecting three basic colors, the projector offers excellent light efficiency and this ensures colorful and bright images. Sony's BrightEra panels deliver improved panel light resistance, higher resolution, high brightness, and increased panel reliability. High color reproducibility is important especially when using colorful content, such as materials typically used in classrooms.

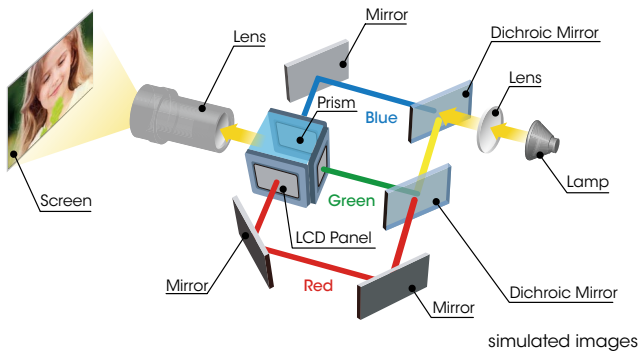

simulated images

High-Resolution Lens

VPL-C200 Series projectors incorporate a high-resolution lens known as the Advanced Crisp Focus (ACF) lens. Its large diameter and fine pitch ensure crisp pictures.

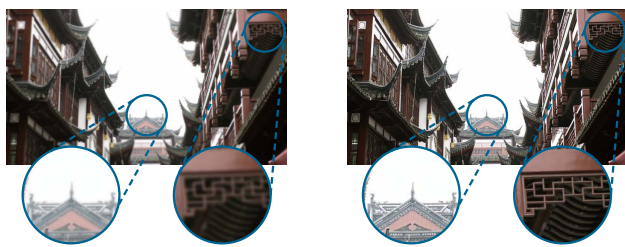

Unoptimized lens

ACF lens

simulated images

Installation Flexibility

Fine Lens Shift

The lens shift function allows image position to be easily fine-tuned vertically or horizontally.

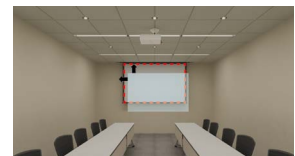
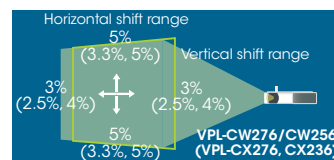

simulated images

Vertical/Horizontal Keystone Distortion

With these projectors, keystone distortion of vertically up to +/- 30 degrees and horizontally up to +/- 20 degrees can be digitally corrected via the on-screen operation menu and/or the Remote Commander™ unit. This enables detailed images to be projected with their correct geometry, even when installation space is limited.

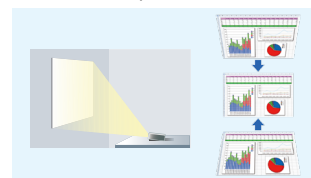

Vertical keystone correction



Horizontal keystone correction

simulated images

Advanced Geometric Correction

Each corner and side can be grabbed and fit squarely to the desired position. This feature is useful when offset projection is necessary.

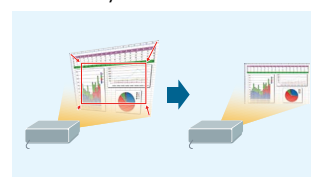

Four corners correction

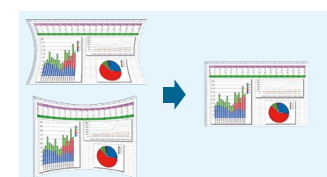

Four sides correction

simulated images

“Blend-in” Design

VPL-C200 Series projectors showcase a new low-profile chassis, so these projectors appear to blend into the ceiling or wall on which they are mounted.

Multiple Inputs & Outputs

These projectors accept a wide variety of input signals including dual HDMI inputs, greatly expanding system connection possibilities.

Good TCO & Energy Efficient

Auto Power Saving Function

- **Auto Mode* (Auto Brightness Adjustment Function)**

The brightness of the lamp’s output is automatically adjusted depending on the brightness of the projected image, to avoid unnecessary power consumption. When showing darker images that don’t require high brightness, lamp output decreases.

* VPL-CW276 and VPL-CX276

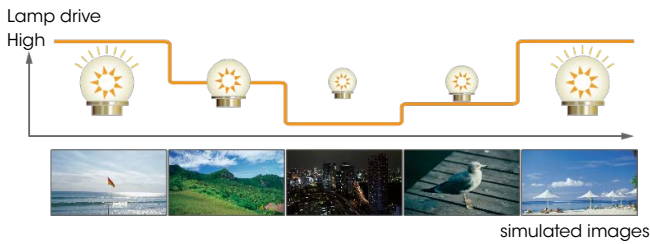

- **Blank**

VPL-C200 Series projectors can temporarily disable video signal output. This function can be easily operated with just the touch of a button on the supplied Remote Commander unit. In addition, this function allows blank image projection with low power consumption using lamp control technology.

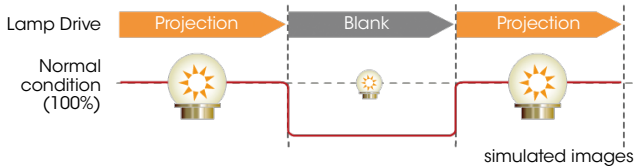

- **Lamp Dimming Function**

These projectors are equipped with a lamp dimming function. After 10 seconds of a static signal feed, the lamp dims by approximately 15% which is hardly noticeable. If one of these projectors is left powered on while not in use, after a set period of time it will automatically detect no change of signal input and will dim the lamp to as low as approximately 30% of original brightness to significantly reduce energy consumption.

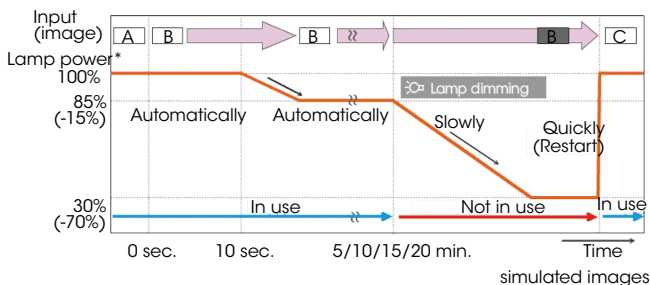

Long-lasting Lamp

By incorporating a high-performance lamp and advanced lamp-control technology, VPL-C200 Series projectors deliver an extremely long lamp replacement time of up to 5,000 hours.*

* Approximate recommended period, in low mode.

Lamp and Filter Synchronized Maintenance

The expected lamp maintenance time for each model can reach up to 5,000 hours* depending on the selected lamp mode, and dust filters require the same maintenance interval. Synchronizing the timing of lamp and filter maintenance enables users to reduce the numbers of “ladder climbs” for maintenance.

* VPL-CW256 and VPL-CX236

ECO MODE Key

With a single push of the ECO MODE key on either the projector or the supplied Remote Commander unit, users can select an energy-saving setting from the ECO Mode menu.

OPTIONAL ACCESSORIES

LMP-C280 / LMP-C240

Projector Lamp (for replacement)

CONNECTOR PANELS

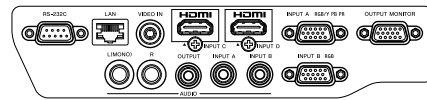

DIMENSIONS

Unit: mm (inches)

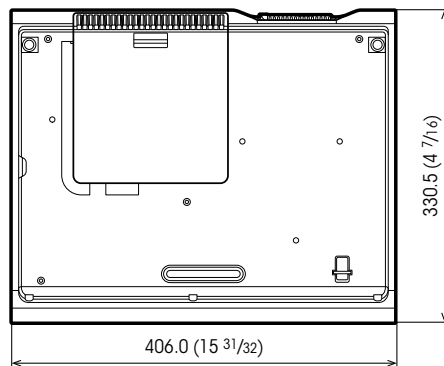
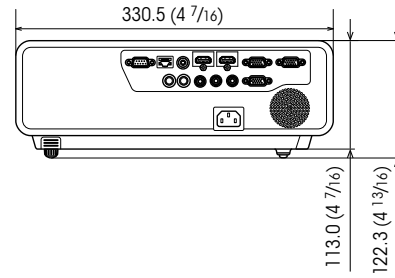
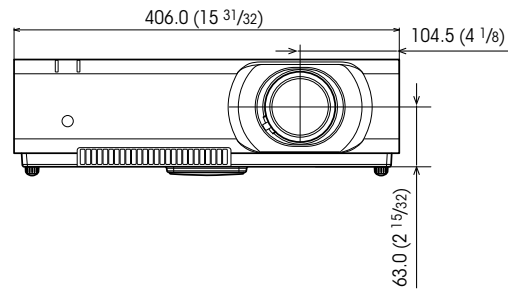

SPECIFICATIONS

		VPL-CW276	VPL-CX276	VPL-CW256	VPL-CX236
Display system		3 LCD system			
Display device	Size of effective display area	0.75" (19.1 mm) x 3, BrightEra, Aspect ratio: 16:10	0.79" (20.1 mm) x 3, BrightEra, Aspect ratio: 4:3	0.75" (19.1 mm) x 3, BrightEra, Aspect ratio: 16:10	0.63" (16 mm) x 3, BrightEra, Aspect ratio: 4:3
	Number of pixels	3,072,000 (1280 x 800 x 3) pixels	2,359,296 (1024 x 768 x 3) pixels	3,072,000 (1280 x 800 x 3) pixels	2,359,296 (1024 x 768 x 3) pixels
	Aspect ratio	16:10	4:3	16:10	4:3
Projection lens	Zoom	Manual (Approx. x1.45)			
	Lens shift	Manual, Vertical: +/- 5.0%, Horizontal: +/- 3.0%	Manual, Vertical: +/- 3.3%, Horizontal: +/- 2.5%	Manual, Vertical: +/- 5.0%, Horizontal: +/- 3.0%	Manual, Vertical: +/- 5.0%, Horizontal: +/- 4.0%
	Throw Ratio	1.32:1 to 1.91:1			1.66:1 to 2.41:1
Light source		UHP lamp 280 W type		UHP lamp 245 W type	
Recommended lamp replacement time*1		3000 H / 4000 H (Lamp mode: High / Standard)		3000 H / 4000 H / 5000 H (Lamp mode: High / Standard / Low)	
Filter cleaning / replacement cycle*1		Same as lamp replacement			
Screen size		40" to 300" (1.02 m to 7.62 m)			
Light output (Lamp mode: High / Standard / Low)*6		5100 lm / 4200 lm / -	5200 lm / 4400 lm / -	4500 lm / 3400 lm / 2500 lm	4100 lm / 3100 lm / 2200 lm
Color light output (Lamp mode: High / Standard / Low)		5100 lm / 4200 lm / -	5200 lm / 4400 lm / -	4500 lm / 3400 lm / 2500 lm	4100 lm / 3100 lm / 2200 lm
Contrast ratio (full white / full black)*2		3000:1		3700:1	3100:1
Displayable scanning frequency	Horizontal	19 kHz to 92 kHz			
	Vertical	48 Hz to 92 Hz			
Display resolution	Computer signal input	Maximum display resolution: UXGA 1600 x 1200 dots*3		Panel display resolution: 1024 x 768 dots	
	Video signal input	NTSC, PAL, SECAM, 480/60i, 576/50i, 480/60p, 576/50p, 720/60p, 720/50p, 1080/60i, 1080/50i			
Color system		NTSC3.58, PAL, SECAM, NTSC4.43, PAL-M, PAL-N, PAL60			
Keystone correction		Vertical: Max. +/- 30 degrees (auto) Horizontal: Max. +/- 20 degrees			
OSD language		24-languages (English, Dutch, French, Italian, German, Spanish, Portuguese, Turkish, Polish, Russian, Swedish, Norwegian, Japanese, Simplified Chinese, Traditional Chinese, Korean, Thai, Vietnamese, Arabic, Farsi, Indonesian, Finnish, Hungarian, Greek)			
Computer and video signal input/output	INPUT A	RGB / Y Pb Pr input connector: Mini D-sub 15-pin (female) Audio input connector: Stereo mini jack			
	INPUT B	RGB input connector: Mini D-sub 15-pin (female) Audio input connector: Stereo mini jack			
	INPUT C	HDMI input connector: HDMI 19-pin, HDCP support			
	INPUT D	HDMI input connector: HDMI 19-pin, HDCP support			
	VIDEO IN	Video input connector: Pin jack Audio input connector: Pin jack (x2)			
	OUTPUT	Monitor output connector*4: Mini D-sub 15-pin (female) Audio output connector*5: Stereo mini jack (variable out)			
Control signal input/output		RS-232C connector: D-sub 9-pin (male) LAN connector: RJ-45, 10BASE-T/100BASE-TX			
Speaker		10 W x 1 (monaural)			
Operating temperature (Operating humidity)		0°C to 40°C / 32°F to 104°F (20% to 80%; no condensation)			
Storage temperature (Storage humidity)		-10°C to +60°C / 14°F to 140°F (20% to 80%; no condensation)			
Power requirements		AC 100 V to 240 V, 4.0 A to 1.7 A, 50 Hz / 60 Hz		AC 100 V to 240 V, 3.5 A to 1.5 A, 50 Hz / 60 Hz	
Power consumption (Lamp mode: High / Standard / Low)	AC 100 V to 120 V	395 W / 341 W / -	389 W / 341 W / -	346 W / 282 W / 241 W	350 W / 328 W / 303 W
	AC 220 V to 240 V	372 W / 320 W / -	367 W / 321 W / -	326 W / 267 W / 230 W	330 W / 311 W / 287 W
Power consumption (Standby mode)	AC 100 V to 120 V	0.5 W (When "Standby mode" is set to "Low")			
	AC 220 V to 240 V	0.5 W (When "Standby mode" is set to "Low")			
Power consumption (Networked Standby mode)	AC 100 V to 120 V	3 W (LAN) (When "Standby mode" is set to "Standard")			
	AC 220 V to 240 V	3 W (LAN) (When "Standby mode" is set to "Standard")			
Heat dissipation	AC 100 V to 120 V	1348 BTU	1327 BTU	1180 BTU	1194 BTU
	AC 220 V to 240 V	1269 BTU	1252 BTU	1112 BTU	1126 BTU
Dimensions (W x H x D) (without protrusions)		W 406 x H 113 x D 330.5 mm (W 15 31/32 x H 4 7/16 x D 13 inches)			
Mass		5.7 kg / 13 lb	5.7 kg / 13 lb	5.6 kg / 12 lb	5.6 kg / 12 lb
Supplied accessories		RM-PJ8 Remote Commander (1), Lithium battery: CR2025 (1), AC Power Cord (1), Mini D-sub 15-pin cable (1), Lens Cap (1), Quick Reference Manual (1), Operating Instructions (CD-ROM) (1)			
Replacement lamp		LMP-C280		LMP-C240	

*1 The figures are the expected maintenance time and not guaranteed. They will depend on the environment or how the projector is used.

*2 This value is average. *3 Available for the VESA Reduced Blanking signal. *4 Not available in standby. From INPUT A and INPUT B.

*5 Works as an audio switcher function. Output from a selected channel; not available in standby. *6 ISO 21118

Distributed by

PEAK
CONFERENCE
www.PeakConference.com

©2015 Sony Corporation. All rights reserved.
Reproduction in whole or in part without written permission is prohibited.
Features and specifications are subject to change without notice.

The values for mass and dimension are approximate.
"SONY", "BrightEra" and "Remote Commander" are trademarks of Sony Corporation.

The terms HDMI and HDMI High-Definition Multimedia Interface, and the HDMI Logo are trademarks or registered trademarks of HDMI Licensing LLC in the United States and other countries. All other trademarks are the property of their respective owners.