

SONY



VPL-CH300 Series

Data Projectors

VPL-CH375 VPL-CH355
VPL-CH370 VPL-CH350



BrightEra™

HDMI

4DDBT™



A great fit for mid-size to large classrooms and meeting rooms when cost is critical

VPL-CH300 Series data projectors deliver an outstanding brightness of up to 5000 lumens and ultra high-quality images with WUXGA resolution.

Sony's 3LCD BrightEra™ panel technology provides higher picture quality, substantially brighter images, higher efficiency, consistent color stability, and longer durability.

In addition, this series delivers installation flexibility, environment-friendly features, and a low total cost of ownership, in a stylish design that blends into any decor. The fine lens shift/zoom capability and the image correction features easily allow users to fit any image onto the screen, even from an offset projection angle. These projectors allow simple connectivity using an HDBaseT™* digital interface multi-signal transmission system. This provides a single-cable, cost-effective, long-distance, and high-quality digital transmission solution. Additionally, these projectors are economically designed for optimum energy efficiency, thanks to energy saving features, and have all the capabilities and functionality that you would expect from Sony, particularly in terms of installation, projection, usability, and maintenance.

*HDBaseT™ and the HDBaseT Alliance logo are trademarks of the HDBaseT Alliance.
VPL-CH375/CH355

High Image Quality

High-resolution WUXGA Image

The VPL-CH300 Series delivers an amazing resolution of WUXGA (1920 x 1200), which exceeds Full-HD resolution (1920 x 1080). It also allows projection in a wider display range. More information can be displayed on screen, so the user can see the whole page without scrolling.

Extremely clear and detailed high-quality images are projected, even on a large screen, and native Full-HD images can be projected full screen. The ground-breaking VPL-CH300 Series offers the ultimate solution for projecting images in a range of applications requiring exceptional detail.

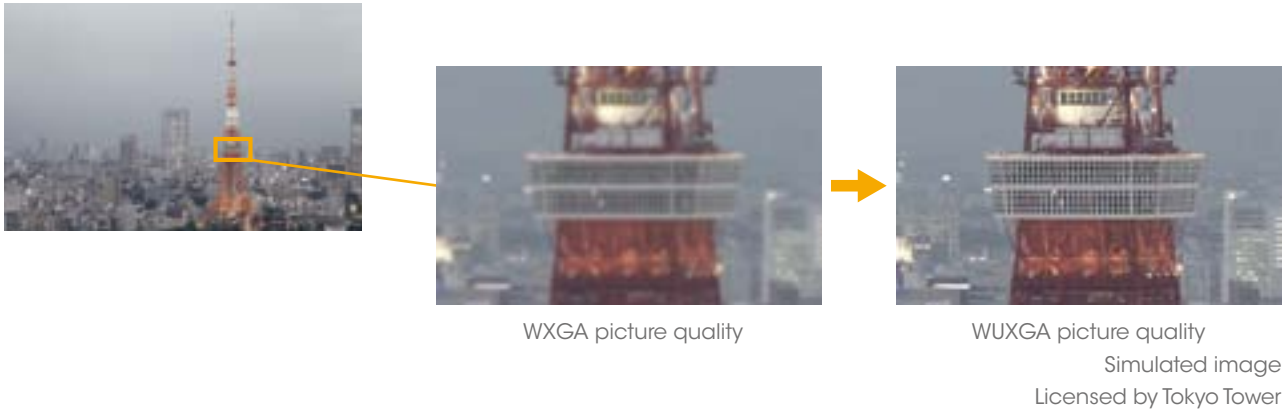

3LCD BrightEra™ Optical System Create WUXGA 5,000 Im* High Brightness and Vivid Color Images

Thanks to the optical system continuously projecting three basic colors, each projector offers excellent light efficiency and this, ensures colorful and bright images. Sony's BrightEra™ panels deliver improved panel light resistance, higher resolution, high brightness, and increased panel reliability. High color reproducibility is important especially when projecting colorful content, such as materials typically used in classrooms.

* VPL-CH375/CH370

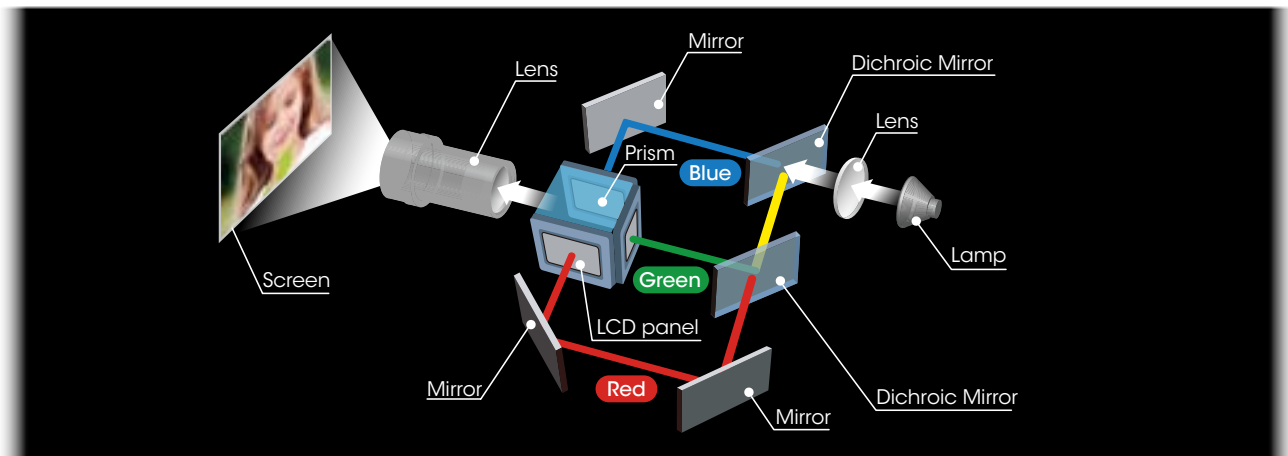

simulated images

High-resolution Lens

The VPL-CH300 Series incorporates a high-resolution lens known as the Advanced Crisp Focus (ACF) lens. Its large diameter and fine pitch ensure crisp pictures.

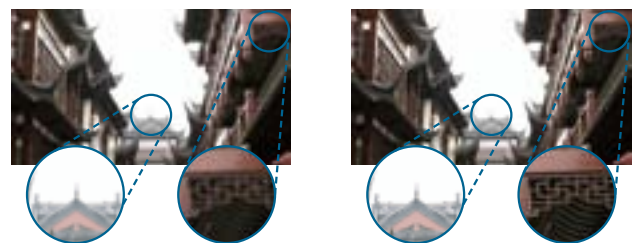

Unoptimized lens

ACF lens

simulated images

Installation Advantages

Fine Lens Shift

The lens shift function allows image position to be easily fine-tuned vertically or horizontally.

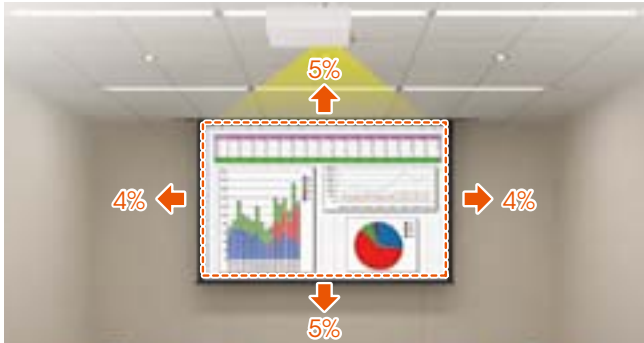

Simulated image

Simple Installation by HDBaseT*

HDBaseT is a multi-signal transmission system via a single cable, which simplifies the installation task. It cuts total system cost by reducing not just cabling requirements but also the number of signal extenders and receiver boxes.

One Cat5e/6 cable can run up to 100 meters, reducing the number of cable runs and eliminating the need for signal extenders. And fewer signal extenders and receiver boxes mean fewer potential points of failure. In addition, Cat5e/6 cables are much easier to terminate than cables such as HDMI, and therefore can be simply and quickly terminated even onsite during the installation process.

* VPL-CH375/CH355

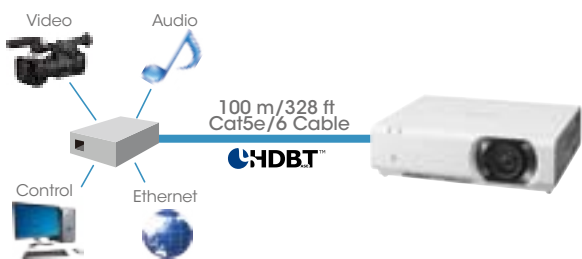

Simulated image

Vertical/Horizontal Keystone Distortion

With these projectors, keystone distortion of vertically up to +/- 30 degrees and horizontally up to +/- 20 degrees can be digitally corrected via the on-screen operation menu and/or the Remote Commander™ unit. This enables detailed images to be projected with their correct geometry, even when installation space is limited.

Advanced Geometric Correction

Each corner can be grabbed and fitted squarely to the desired position. This feature is useful when offset projection is necessary.

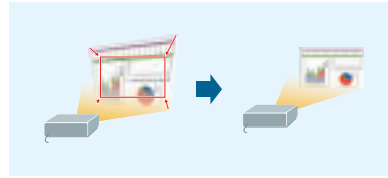

Four corners correction

Simulated image

Blend-in Design

VPL-CH300 Series projectors come in white, and have a simple, stylish design that fits any modern environment. A flat top surface enables unobtrusive ceiling mounting.



In the meeting room



In the classroom

Simulated image

Good TCO, Energy-efficient Design

Energy Efficient with Long-lasting Lamp

By incorporating a high-performance lamp and advanced lamp-control technology, Sony's projectors deliver an extremely long lamp replacement time.

Synchronized Maintenance

The lamp and dust filters require the same maintenance interval. Synchronizing the timing of lamp and filter maintenance enables users to reduce the numbers of maintenance 'ladder climbs'.

Auto Power Saving Function

• Auto Mode* (Auto Brightness Adjustment Function)

The brightness of the lamp's output is automatically adjusted depending on the brightness of the projected image, to avoid unnecessary power consumption. When showing darker images that do not require high brightness, lamp output decreases.

* VPL-CH375/CH370

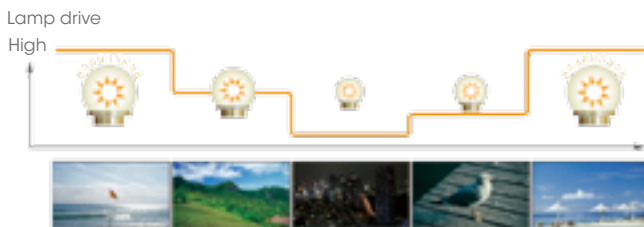

Simulated image

• Blank

VPL-CH300 Series projectors can temporarily disable video signal output. This function is easily operated with just the touch of a button on the supplied Remote Commander™ unit. In addition, this function allows blank image projection with low power consumption using lamp control technology.

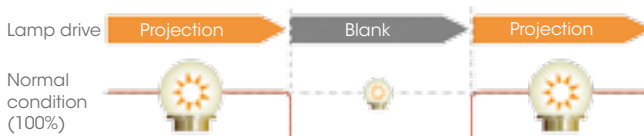

Simulated image

• Lamp Dimming Function

These projectors are equipped with a lamp dimming function. After 10 seconds of a static signal feed, the lamp dims by approximately 15% which is hardly noticeable. If one of these projectors is left powered on when not in use, after a set period of time, it automatically detects no change of signal input and will dim the lamp to as low as approximately 30% of original brightness to significantly reduce energy consumption.

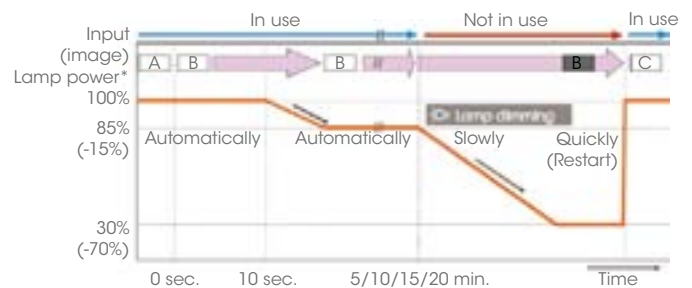

Simulated image

ECO MODE Key

With a single push of the ECO MODE key on either the projector or the supplied Remote Commander unit, users can select an energy-saving setting from the ECO Mode menu.



Ease of Use

Network Presentation (LAN)

When one of these projectors is installed on a LAN, presentations can be projected from any PC and Mac on the network. A tablet or smart phone can also be connected at the same time. Users can project jpg, pdf, and other supported formats. Up to four users can project PC / Mac images simultaneously, while up to eight*¹ users can connect to one projector.

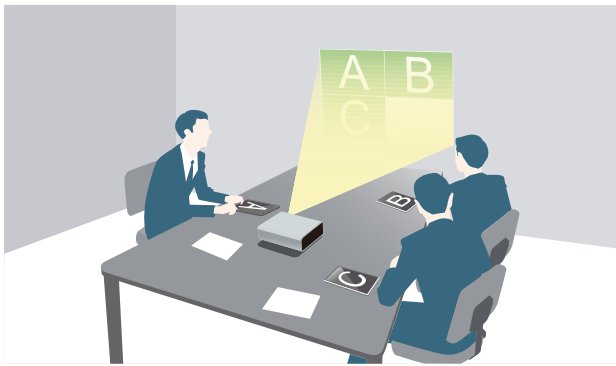

Wireless Presentation Software

For MS Windows / Mac OS: Projector Station for Network Presentation

For iOS / Android OS: VueMagic*²

*¹ Up to seven users for wireless.

*² The application for tablets and smartphones is provided by Pixelworks. For details, please visit the following website: <http://PWPresenter.pixelworks.com>



Case1

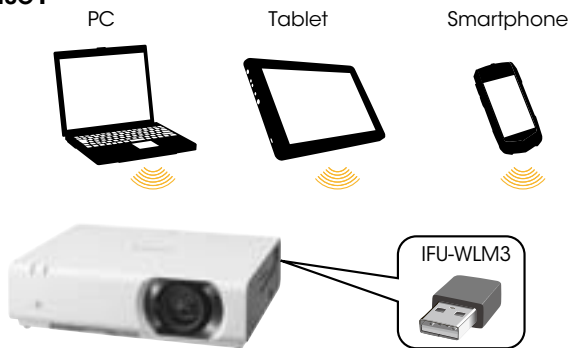

For wireless connection, the IFU-WLM3 is required.

Case2

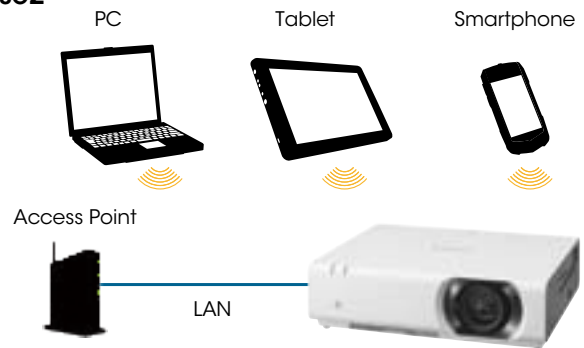

Remote Control for iPhone / iPad

Projector Remote is a simple remote control application for Sony's projectors. Networked projectors can be controlled by this remote application, and remote control allows users to operate the projector using simple and easy-to-read buttons.

* Projector Remote Application: scan the QR code to download FREE today.



Projector Remote



USB Display

These projectors allow users to display pictures and audio* with just one USB cable. There's no need to install any driver for this function. This is a convenient and very easy way to connect to the projector.

* There is a time lag in video and audio. Beyond basic usage, Line-in or HDMI-in is recommended.

Other Features

Closed Captioning

Official teletext broadcasting, developed by the NCI, USA

Network and Control

Controls and monitors projector status
Compatible with various control systems



OPTIONAL ACCESSORIES



CONNECTOR PANELS

VPL-CH375 / VPL-CH355

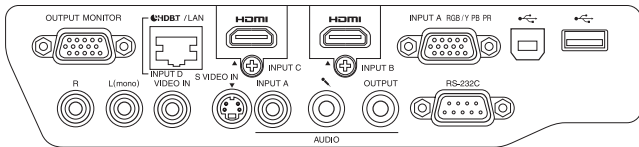

VPL-CH370 / VPL-CH350

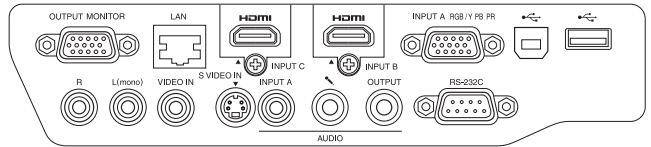

DIMENSIONS

Front

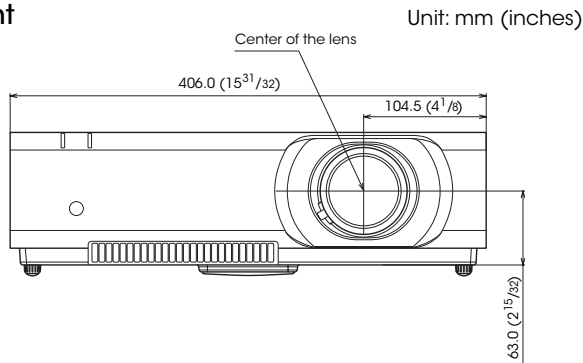

Bottom

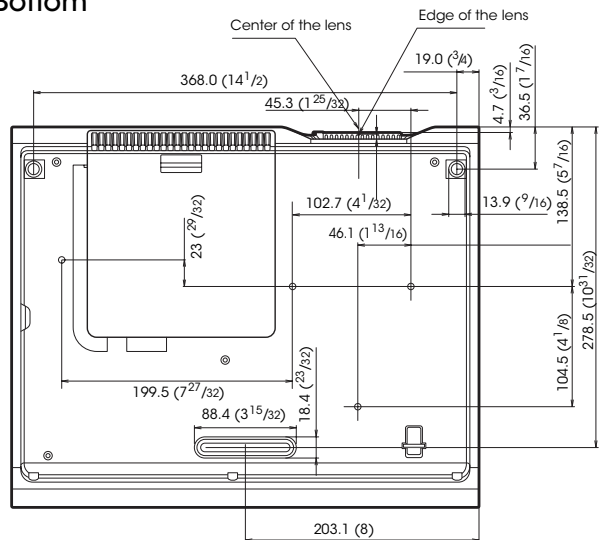

SPECIFICATIONS

		VPL-CH375	VPL-CH370	VPL-CH355	VPL-CH350
Display system		3 LCD system			
Display device	Size of effective display area	0.64" (16.3 mm) × 3, Aspect ratio: 16:10			
	Number of pixels	6,912,000 (1920 × 1200 × 3) pixels			
	Aspect ratio	16:10			
Projection lens	Zoom	Manual (Ratio: Approx. x 1.45)			
	Focus	Manual			
	Lens shift	Manual (Vertical: +/- 5%, Horizontal: +/- 4%)			
	Throw Ratio	1.5:1 to 2.2:1			
Light source		Ultra high pressure mercury lamp 280 W type		Ultra high pressure mercury lamp 250 W type	
Recommended lamp replacement time		2500 H / 3000 H / 3500 H (Lamp mode: High / Standard / Low)		3000 H / 4000 H / 5000 H (Lamp mode: High / Standard / Low)	
Screen size		40" to 300" (1.02 m to 7.62 m)(measured diagonally)			
Light output (Mode: High / Standard / Low)		5000 lm / 3600 lm / 3100 lm		4000 lm / 3200 lm / 2600 lm	
Color light output (Mode: High / Standard / Low)		5000 lm / 3600 lm / 3100 lm		4000 lm / 3200 lm / 2600 lm	
Contrast ratio (full white / full black)		2500:1			
Displayable scanning frequency	Horizontal	19 kHz to 92 kHz			
	Vertical	48 Hz to 92 Hz			
Display resolution	Computer signal input	Maximum display resolution: 1920 × 1200 dots *1 / Panel display resolution: 1920 × 1200 dots			
	Video signal input	480/60i, 576/50i, 480/60p, 576/50p, 720/60p, 720/50p, 1080/60i, 1080/50i The following item are available for digital signal only: 1080/60p, 1080/50p, 1080/24p			
Color system		NTSC3.58, PAL, SECAM, NTSC4.43, PAL-M, PAL-N			
Keystone correction		Vertical: Max. +/- 30 degrees, Horizontal: Max. +/- 20 degrees			
OSD language		24-language (English, French, German, Italian, Spanish, Portuguese, Japanese, Simplified Chinese, Traditional Chinese, Korean, Russian, Dutch, Norwegian, Swedish, Thai, Arabic, Turkish, Polish, Vietnamese, Farsi, Indonesian, Finnish, Hungarian, Greek)			
INPUT OUTPUT (Computer/Video/Control)	INPUT A	RGB / YPbPr input connector: Mini D-sub 15 pin female, Audio input connector: Stereo mini jack			
	INPUT B / INPUT C	HDMI input connector: HDMI 19-pin, HDCP support			
	INPUT D	HDBaseT	-	HDBaseT	-
	S-VIDEO IN	S-video input connector: Mini DIN 4-pin			
	VIDEO IN	Video input connector: Phono jack			
	OUTPUT	Monitor output connector*2: Mini D-sub 15-pin (female), Audio output connector*2: Stereo mini jack			
	REMOTE	D-sub 9-pin (male)			
	LAN	RJ45, 100BASE-TX (Shared with HDBaseT)	RJ45, 10BASE-T/100BASE-TX	RJ45, 100BASE-TX (Shared with HDBaseT)	RJ45, 10BASE-T/100BASE-TX
	HDBaseT	RJ45, 4 Play	-	RJ45, 4 Play	-
	USB	Type-A, Type-B			
	MICROPHONE IN	Mini jack			
Speaker		12W × 1 (monaural)			
Operating temperature (Operating humidity)		0°C to 40°C / 32°F to 104°F (20% to 80%; no condensation)			
Storage temperature (Storage humidity)		-10°C to +60°C / 14°F to 140°F (20% to 80%; no condensation)			
Power requirements		AC 100 V to 240 V, 3.6 A to 1.6 A, 50/60 Hz			
Power consumption (Lamp mode: High / Standard / Low)	AC 100 V to 120 V	388 W / 315 W / 279 W		353 W / 285 W / 265 W	
	AC 220 V to 240 V	367 W / 299 W / 266 W		334 W / 272 W / 254 W	
Standby mode power consumption (Standby mode: Standard / Low)	AC 100 V to 120 V	6.1 W / 0.3 W	4.7 W / 0.3 W	6.1 W / 0.5 W	4.7 W / 0.5 W
	AC 220 V to 240 V	6.2 W / 0.5 W	4.9 W / 0.5 W	6.2 W / 0.5 W	4.9 W / 0.5 W
Heat dissipation	AC 100 V to 120 V	1323 BTU		1204 BTU	
	AC 220 V to 240 V	1252 BTU		1139 BTU	
Outside dimensions (W × H × D)		Approx. 406 × 113 × D 330.5 mm (15 31/32 × 4 7/16 × 13 in) (without protrusions)			
Mass		Approx. 5.7 kg / 12 lb			
Supplied accessories		RM-PJ8 Remote Commander (1), Lithium battery: CR2025 (1), AC Power Cord (1), Lens cap (1), Quick Reference Manual (1), Operating Instructions (CD-ROM) (1), Presentation Station for Network Presentation application (CD-ROM) (1)			

*1 Available for VESA Reduced Blanking signal. *2 From INPUT A.

Distributed by

MK11137V2YIT14AUG



©2014 Sony Corporation. All rights reserved.
 Reproduction in whole or in part without written permission is prohibited.
 Features and specifications are subject to change without notice.
 The values for mass and dimension are approximate.
 "SONY", "BrightEra" and "Remote Commander" are trademarks of Sony Corporation.
 Trademark PJLink is a trademark applied for trademark rights in Japan, the United States of America and other countries and areas.
 The terms HDMI and HDMI High-Definition Multimedia Interface, and the HDMI Logo are trademarks or registered trademarks of HDMI Licensing LLC in the United States and other countries.
 Pixelworks and VueMagic™ are trademark of Pixelworks Inc.
 App Store is a service mark of Apple Inc.
 HDBaseT™ and the HDBaseT Alliance logo are trademarks of the HDBaseT Alliance.
 All other trademarks are the property of their respective owners.